

F015 322 024

Issue } 11-01-27
Stand }

Fig./Abb. 1

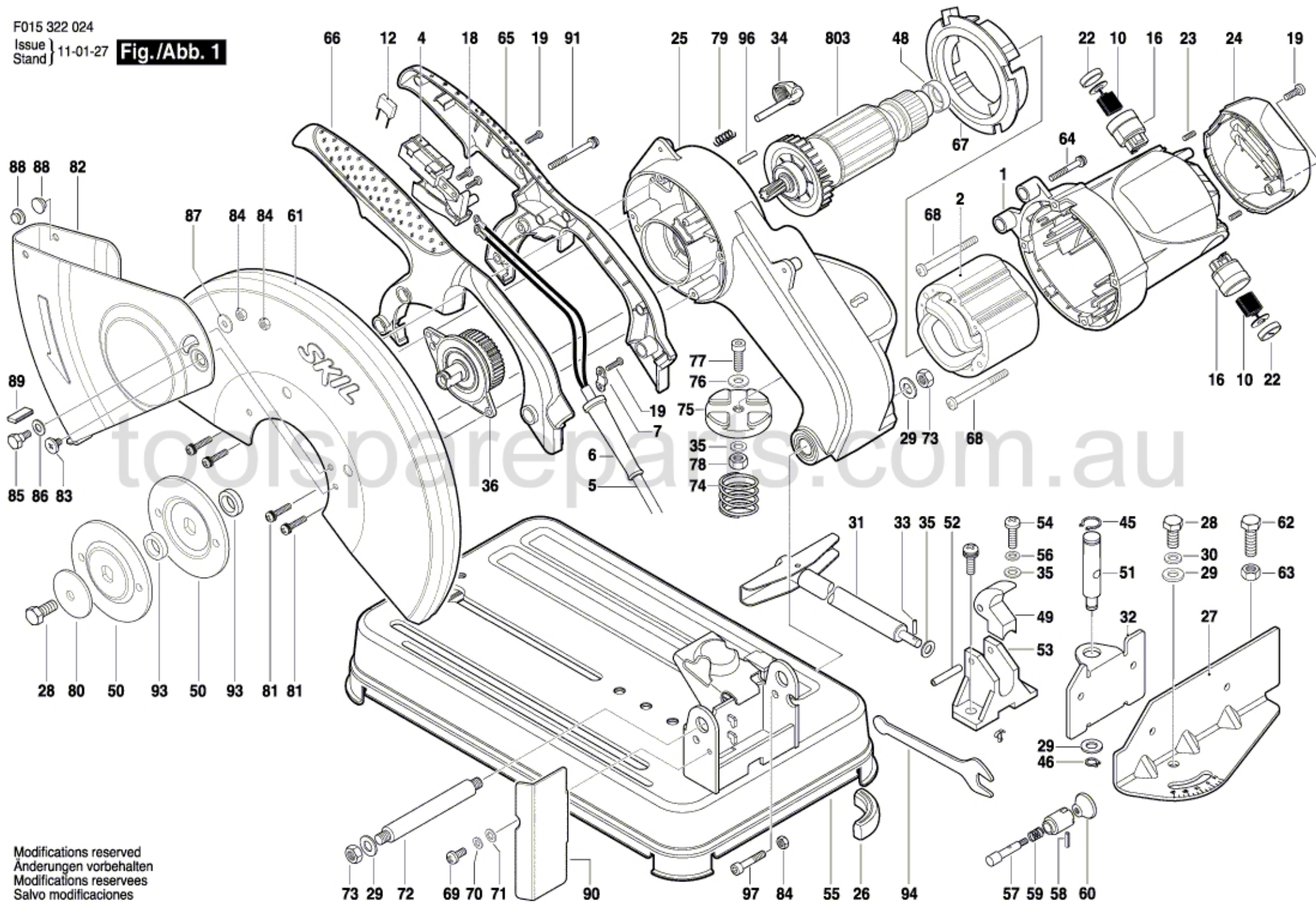

Modifications reserved
Änderungen vorbehalten
Modifications reserves
Salvo modificaciones